

marlon **fs**

Solid Polycarbonate Sheet

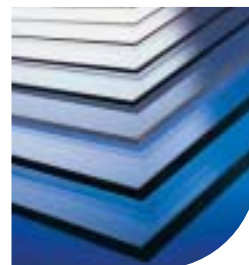



Brett Martin's sheet products are respected around the world for their record in the construction industry.

The Marlon range of polycarbonate sheets represent ideal solutions in structured, corrugated and flat forms for a wide range of applications and projects. Marlon FS flat sheet is the most versatile of these materials offering the very highest levels of glazing performance.

marlon fs[®]



POLYCARBONATE

Durability and design freedom are two of the key features which designers seek when selecting modern materials. Marlon FS offers both features plus many more benefits over traditional glazing and fabrication alternatives.

Marlon FS is clearly transparent, maximising light transmission when required and through tints can also offer solar control. The strength of polycarbonate is now legendary, with unbeatable impact resistance, yet it remains flexible enough to be cold bent on site for curved applications.

For use in the world's toughest climatic conditions we have developed Marlon FSX Longlife featuring co-extruded UV protection on both sides of the sheet, which enhances its weather resistance and performance.

Together these features represent an unequalled combination of properties in a material manufactured to the highest international quality standards.





glazing

Marlon FS flat polycarbonate sheet offers a superior glazing solution to that of other materials, particularly when safety or impact resistance is of vital importance.

The criteria for safe, attractive and practical glazing in hospitals, schools, sporting facilities and other public areas are easily met through the use of Marlon FS.





Safety

With an impact strength up to 200 times greater than glass, Marlon FS remains virtually unbreakable, offering protection for those working or playing beneath it.

Design Flexibility

Marlon FS can easily be cold curved on site, enabling the designer to create interesting glazing solutions for a bright, naturally lit interior environment. Marlon FS provides light transmissions of up to 90%.

Economy

Resistance to breakage through vandalism can dramatically reduce a building's maintenance costs and, in addition, Marlon FS can help reduce energy costs through its superior thermal properties over glass.

Durability

Marlon FS has excellent resistance to the weather and atmospheric conditions. Marlon FSX Longlife grade sheet offers a guarantee for continued performance in prolonged outdoor exposure.

Practicality

The weight of Marlon FS sheets is only half that of plate glass, making handling and installation ultimately more convenient. The sheets can be installed or fabricated with the minimum of specialist tools or labour.

Quality

Marlon FS is manufactured by Brett Martin in its state of the art extrusion facility complying with international quality standards certified to BS EN ISO 9001:2000.

marlon fsx[®]
LONGLIFE

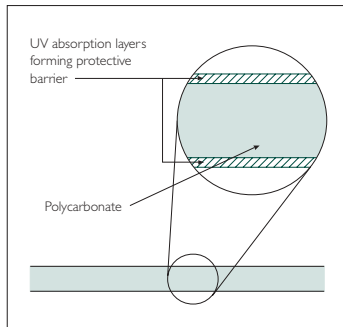

Co-extruded UV Protection

Marlon FSX Longlife has a high performance UV absorption layer co-extruded on both surfaces which prevents damaging UV radiation from penetrating the sheet. UV protection means longer life, preventing yellowing and loss of strength. It cuts out 98% of harmful UV radiation, protecting those working or playing beneath it.



RANGE

SHEET SIZE (mm)		SHEET THICKNESS (mm)
Marlon FS	1220 x 2440	3, 4, 5, 6
	2050 x 1250	3, 4, 5, 6
	2050 x 2500	2, 3, 4, 5, 6
	2050 x 3050	2, 3, 4, 5, 6, 8, 10, 12
Marlon FSX Longlife	1220 x 2440	3, 4, 6
	2050 x 1250	2, 3, 4, 5, 6, 8, 10, 12
	2050 x 3050	2, 3, 4, 5, 6, 8, 10, 12
Marlon FSX Textured	2050 x 3050	3, 4, 6

Brett Martin constantly reviews its standard ranges. Please contact your distributor for the latest range availability. The entire range is available in clear and several sizes and thicknesses in tints. Tinted options can be manufactured in all sizes but are subject to minimum order quantities. Numerous variations are possible and Marlon FS can be manufactured to meet special requirements.* Do not hesitate to contact your distributor to discuss your particular requirements.

* Bespoke orders will be subject to a minimum order quantity.

Warranty

Marlon FSX Longlife carries a guarantee against light transmission and breakage as outlined in the warranty statement, available separately.





applications



marlon fs[®]

marlon fsx[®]
LONGLIFE

Marlon FS can be used in a variety of applications which require its high performance features.

These include general glazing, roofing, safety glazing, protective screening, visors and fabrication for interior and exterior uses.

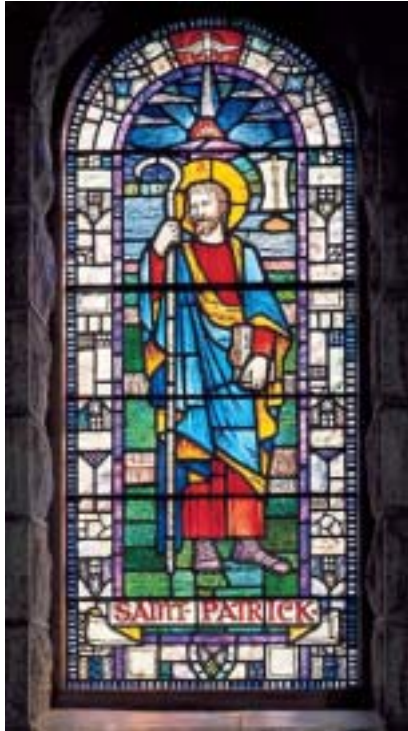

3



4



5



6



7



8



9

1. VAULT ROOFLIGHTS 2. CURVED ROOFS 3. ANTI-VANDAL SECONDARY GLAZING 4. DOME ROOFLIGHTS 5. MACHINE GUARDS 6. ARCHITECTURAL FEATURES 7. PROTECTIVE CASINGS 8. PROTECTIVE VISORS 9. SHELTERS

PROPERTIES

PROPERTIES	TEST METHOD	UNITS	VALUE
Physical			
Density	DIN 53479	g/cm ³	1.2
Light Transmission (3mm thick, clear)	DIN 5036	%	88
Refractive Index	DIN 53491		1.585
Mechanical			
Tensile strength at yield	DIN 53455	N/mm ²	>60
Tensile strength at break	DIN 53455	N/mm ²	>70
Modulus of Elasticity	DIN 53457	N/mm ²	2300
Impact strength @ 23°C (notched Charpy)	DIN 53453	kJ/m ²	>30
Thermal			
Linear Expansion Coefficient	DIN 52612	1/K	68 x 10 ⁻⁶
Thermal conductivity	DIN 52612	W/mK	0.21
Heat deflection Temperature Load 1.81 N/mm ²	DIN 53461	°C	135
Maximum continuous service temperature	DIN 53461	°C	100

Fire Performance

COUNTRY	THICKNESS (mm)	TEST METHOD	CLASSIFICATION	CERTIFICATE NO.
UK	3	BS2782: 1970: Method 508A		WARRES No. 56933
UK	3	BS476: Part 7: 1987	Class 1Y	WARRES No. 66300
France	3	892/2002	Class M2	5120606-DMAT/1
Germany	3	P-MPA-E-00-612	Class B1	16-22633/1
UK	3 (embossed)	BS476: Part 7: 1987	Class 1Y	WARRES No. 70651

Light Transmission to DIN 5036 (%)

COLOUR CODE	1mm	2mm	3mm	4mm	5mm	6mm	8mm	10mm	12mm
Clear S	90	89	88	87	86	86	86	84	82
Clear S (Embossed)	-	-	84	83	82	81	77	-	-
Bronze CE	-	-	54	53	54	54	53	51	-
Bronze JL	-	-	37	39	-	-	-	-	-
Green CF	-	-	41	38	-	41	-	-	-
Blue LM	-	-	-	-	-	14	-	-	-
Opal FH	-	-	37	32	31	26	-	-	-
Grey IM	-	-	-	33	-	35	-	-	-

With light transmission of between 82% and 90%, clear Marlon FS offers excellent clarity.

Thermal Transmittance - U Value

THICKNESS (mm)	MARLON FSX (W/m ² K)	GLASS (W/m ² K)
2	5.56	-
3	5.41	5.87
4	5.27	5.82
5	5.13	5.80
6	5.00	5.77
8	4.76	5.71
10	4.55	-
12	4.35	-

Marlon FS has a 'U' value and therefore heat loss significantly lower than glass.

Weight

THICKNESS (mm)	MARLON FS (kg/m ²)	GLASS (kg/m ²)
2	2.4	5.00
3	3.6	7.50
4	4.8	10.00
5	6.0	12.50
6	7.2	15.00
8	9.6	20.00
10	12.0	25.00
12	14.4	30.00

At just about half the weight of glass, Marlon FS offers savings in handling, transportation and installation.

Tensile Strength

Measured on injection moulded test specimens.

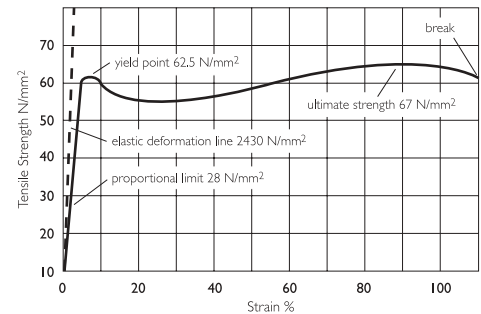

Thermal Expansion

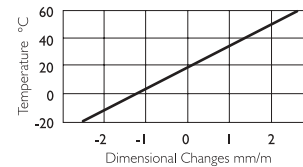

Flexural Modulus v Temperature

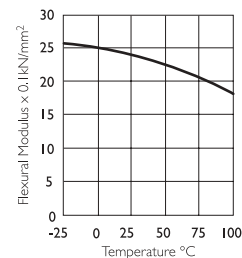

Tensile Strength v Temperature

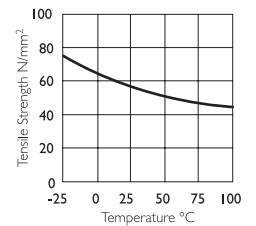

FABRICATING GUIDELINES

CUTTING

Marlon FS is easy to saw and cut on standard workshop equipment. It can be machined on conventional milling machines with standard high speed tools. Notches adversely affect the mechanical properties of polycarbonate and should be avoided.

RECOMMENDATIONS	CIRCULAR SAW	BAND SAW	MILLING MACHINE
CLEARANCE ANGLE	20-30°	20-30°	20-25°
RAKE ANGLE	15°	0.5°	0-5°
CUTTING SPEED	1800-2400 m/min	600-1000 m/min	100-500 m/min
FEED SPEED	19-25 m/min	20-25 m/min	0.1-0.5 mm/rev
TOOTH SPACING	2-5 mm	1.5-2.5 mm	-

DRILLING

Any commercially available metal drill without a specially ground bit is suitable for use with Marlon FS.

Drill Data

PARAMETER	VALUE
Clearance angle α	5-8°
Tip angle φ	90-130°
Helix angle β	ca 30°
Rake angle γ	3-5°
Cutting speed	0.1-0.5mm/rpm
Drill tip speed	10-60m/min

The following points should be observed when drilling Marlon FS:

- Do not use cutting oils with Marlon FS
- The sheet may break as a result of notching
- Fixing threads should only be used if there is no other alternative (through-hole, bonding, clamping)

NB - The hole should be at least 1.5 x hole diameter from the sheet edge.

THERMOFORMING & HOT BENDING

Before thermoforming, remove masking films and pre-dry at 120°C to remove absorbed moisture. Air circulation ovens with accurate temperature control are most efficient - air must circulate

between sheets. Sheet age and storage conditions determine drying time. Dry storage can reduce pre-drying time in oven by up to one third - some experimentation is usually necessary. As moisture re-absorption starts when the dried sheet temperature falls below 100°C, thermoforming should be performed immediately after drying. Pre-drying is not normally required when hot line bending.

Guidelines for Drying

SHEET THICKNESS (mm)	DRYING TIME AT 120°C (hr)
2	4
3	8
4	13
5	18
6	24
8	38
10	30
12	33

Marlon FS can be moulded on any standard vacuum or pressure forming equipment. Forming can be made at temperatures between 175°C and 200°C. When the mould temperature falls below 125°C formed parts can be removed. Mould shrinkage will be between 0.5% and 1.0%.

The recommended temperature for hot bending is between 155°C and 165°C.



COLD CURVING

Marlon FS can easily be cold curved. At low radii high stresses are built up in the material which will lower chemical resistance. Radii should be as large as possible to minimise stresses.

The minimum allowable radius for cold curved applications is SHEET THICKNESS x 175. This incorporates a factor of safety to cope with the stress effects produced by curving and environmental stress factors.

BONDING

The material can be bonded using one of the following adhesives; Epoxy, Polyurethane, Hot Melt or Silicone. Ask your adhesive supplier for the most appropriate type of adhesive for your particular application. Solvents such as Methylene Chloride give a good bond but can lead to stress cracking and are therefore not recommended.

CLEANING

A mild detergent with lukewarm water and a soft cloth or sponge should be used to clean Marlon FS. Always rinse thoroughly with clean water. Ethyl Alcohol can be used to remove paint and other such substances. This should always be washed and rinsed thoroughly afterwards.

GENERAL INSTALLATION

Marlon FS can be installed in most types of frames including PVC, wood, steel and aluminium. The framing system must retain the sheet but allow thermal movement.

Only compatible sealants must be used, these include silicone, EPDM, neoprene or 'plasticiser free' chloroprene materials of proven performance. Please note that PVC gaskets are not compatible with polycarbonate.

EXPANSION ALLOWANCE

Care must be taken when cutting sheets to allow space for thermal expansion to avoid stress or bowing with temperature change (see table below). Allowance must be made in both length and width. In vertical installations the expansion allowance must be left at the top of the frame and at both sides.

Expansion Allowance

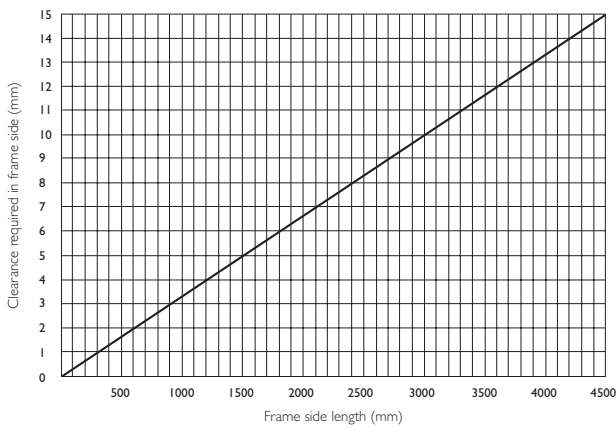

SHEET SIZING

Use the table below to calculate the required trimming of Marlon FS to allow for expansion dependent on the sash dimensions.

SASH DIMENSIONS 'F' mm	TRIM MARLON FS BY 'E' mm
300-1000	3 mm
1000-1300	4 mm
1300-1700	5 mm
1700-2000	6 mm
2000-2300	7 mm
2300-2700	8 mm
2700-3000	9 mm

EDGE ENGAGEMENT

Each rebate detail must allow enough depth to include the expansion allowance plus a sufficient sheet edge engagement to prevent sheet 'pop-out' from the frame.

Rebate depth 'R' and edge engagement 'G'

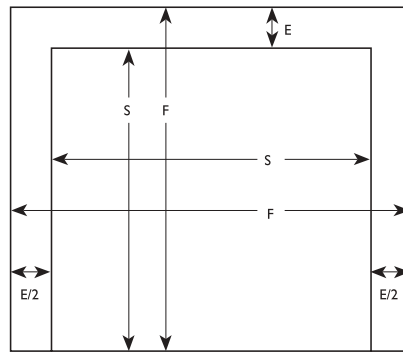
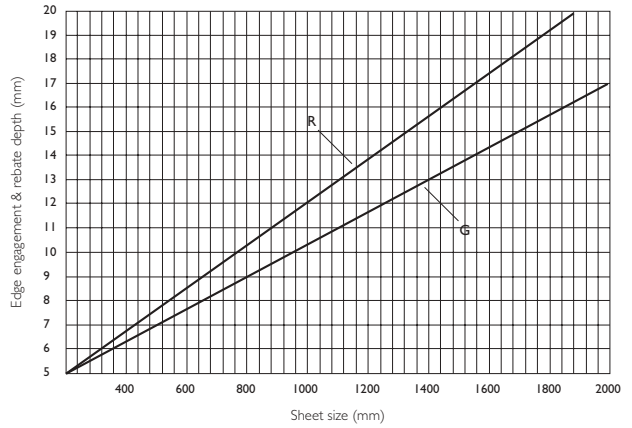

Window Section

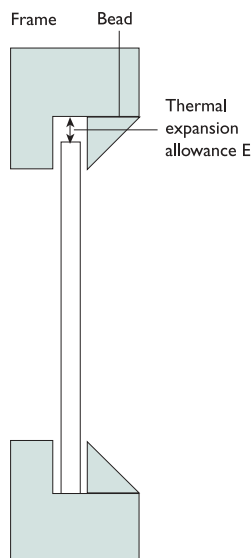

Frame Section

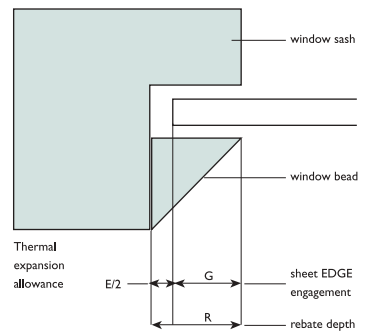

SHEET THICKNESS

The following charts indicate the required sheet thickness to maintain sheet deflection to a maximum of 50mm and assumes four side edge engagement. Having first calculated the effective area of the sheet, the required thickness for a given wind load can be selected. Guidance is also available from BS5516.

Calculation of the Effective Sheet Area

Sheet Width (m)	Sheet Length (m)																			
	0.25	0.5	0.75	1.0	1.25	1.5	1.75	2.0	2.25	2.5	2.75	3.0	3.25	3.5	3.75	4.0	4.25	4.5	4.75	5.0
0.25	A1	A1	A1	A1	A1	A1	A1	A1	A1	A1	A1	A1	A1	A1	A1	A1	A1	A1	A1	A1
0.5	A1	A2	A3	A4	A4	A4	A4	A4	A4	A4	A4	A4	A4	A4	A4	A4	A4	A4	A4	A4
0.75	A1	A3	A5	A6	A7	A7	A7	A7	A7	A7	A7	A7	A7	A7	A7	A7	A7	A7	A7	A7
1.0	A1	A4	A6	A8	A9	A9	A10	A10	A10	A10	A11	A11	A11	A11	A11	A11	A11	A11	A11	A11
1.25	A1	A4	A7	A9	A10	A11	A12	A13	A13	A14	A14	A14	A14	A14	A14	A14	A14	A14	A14	A14
1.5	A1	A4	A7	A9	A11	A13	A14	A15	A16	A16	A16	A17	A17	A17	A17	A17	A17	A17	A17	A17
1.75	A1	A4	A7	A10	A12	A14	A16	A17	A18	A19	A19	A19	-	-	-	-	-	-	-	-
2.0	A1	A4	A7	A10	A13	A15	A17	A18	A19	-	-	-	-	-	-	-	-	-	-	-

Selection of Sheet Thickness in mm

Load kN/m ²	Effective Area																		
	A1	A2	A3	A4	A5	A6	A7	A8	A9	A10	A11	A12	A13	A14	A15	A16	A17	A18	A19
0.6	3	3	4	4	5	5	6	6	8	8	10	10	10	10	10	12	12	12	12
0.8	3	3	4	4	5	6	6	6	8	8	10	10	10	12	12	12	12	12	-
1.0	3	4	4	5	5	6	8	8	8	10	10	10	10	12	12	-	-	-	-
1.2	3	4	4	5	5	6	8	8	8	10	10	12	12	-	-	-	-	-	-
1.4	3	4	5	6	6	8	8	8	10	10	12	12	-	-	-	-	-	-	-

CURVED INSTALLATION

Marlon FS can be installed in a curved glazing system on site, without prior forming. The thickness of sheet that must be used will depend upon the curvature and the span, the distance between glazing bars and the maximum load that will be applied to the sheets.

Each sheet thickness has a minimum allowable radius.

THICKNESS 't' (mm)	MINIMUM RADIUS 'r' (mm)
2	350
3	525
4	700
5	875
6	1050
8	1400
10	1750
12	2100

The critical load at which buckling will occur is a function of the geometry of the structure and the intrinsic properties of Marlon FS.

A safety factor of 1.5 is applied in all cases.

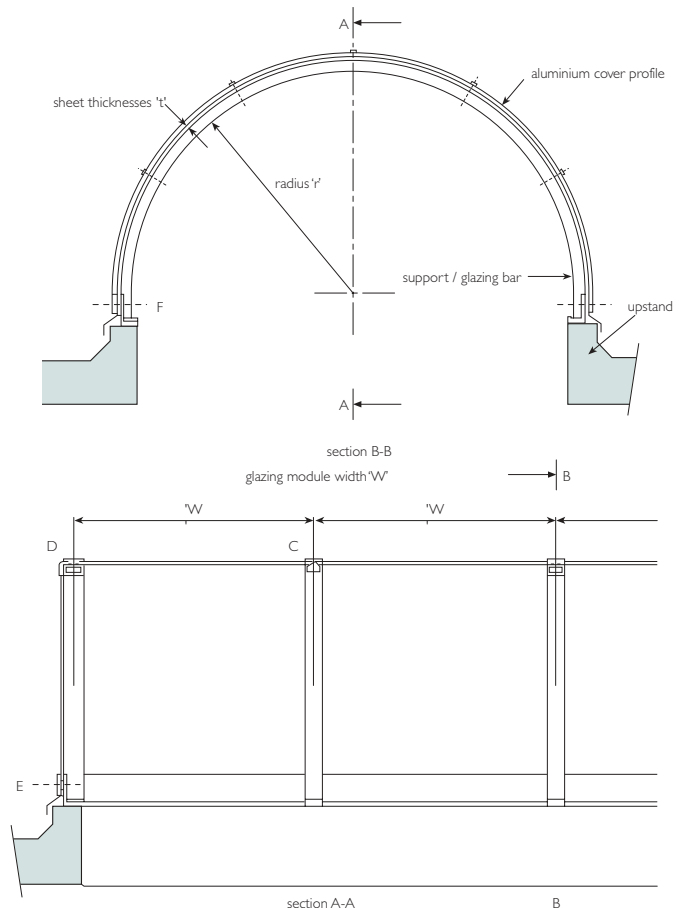

All reasonable care has been taken in the compilation of the information contained within this literature. All recommendations on the use of our products are made without guarantee as conditions of use are beyond the control of Brett Martin. It is the customer's responsibility to ensure that the product is fit for its intended purpose and that the actual conditions of use are suitable. Brett Martin pursues a policy of continuous product development and reserves the right to amend specifications without prior notice. The photographs used are for illustration purposes only and simply indicate possible uses of Marlon FS.

Brett Martin Ltd

24 ROUGHFORT ROAD
MALLUSK, CO ANTRIM
UK, BT36 4RB

TEL: +44 (0) 28 9084 9999

FAX: +44 (0) 28 9083 6666

Email: mail@brettmartin.com

**Brett Martin
Semi-Finished Products**

LANGLEY ROAD
BURSCOUGH INDUSTRIAL ESTATE
BURSCOUGH, LANCASHIRE
ENGLAND, L40 8JR

TEL: +44 (0) 1704 895345

FAX: +44 (0) 1704 898628

Email: semifinished@brettmartin.com

Brett Martin Scotland Ltd

BLAIRLINN ROAD
CUMBERNAULD, GLASGOW
SCOTLAND, G67 2TF

TEL: +44 (0) 1236 725536

FAX: +44 (0) 1236 725871

Email: scotland@brettmartin.com

Brett Martin International BV

NOORDMEERSTRAAT 13
2131 AD HOOFDDORP
NETHERLANDS

TEL: +31 (0) 23 5540955

FAX: +31 (0) 23 5540966

Email: international@brettmartin.com



Brett Martin's Marlon brand of Polycarbonate includes ranges of flat, corrugated and structured sheet.

FOR THE LATEST INFORMATION
VISIT THE COMPANY'S WEB SITE:

<http://www.brettmartin.com>



BS EN ISO 9001:2000

BRETT MARTIN

824SF07057